

# Time and Frequency Transmission Facilities

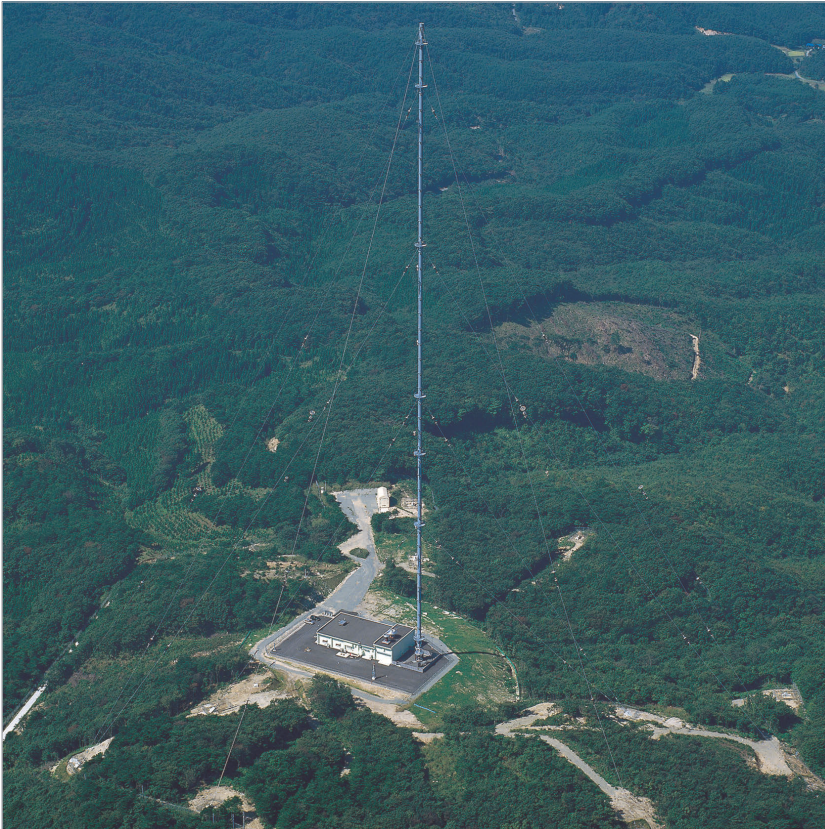

▲Ohtakadoya-yama LF Standard Time and Frequency Transmission Station

## Disseminating accurate Japan Standard Time (JST)!

- Time synchronization of radio clocks
- Time standard for broadcasting and telephone time signal services

## Providing highly precise frequency standards!

- Frequency standard for measuring instruments
- Frequency synchronization of radio instruments



▲Hagane-yama LF Standard Time and Frequency Transmission Station

# Low-Frequency Standard Time and Frequency Transmission

The National Institute of Information and Communications Technology (NICT) determines and maintains the time and frequency standard and Japan Standard Time (JST) in Japan as the sole organization responsible for the national frequency standard. Japan Standard Time and Frequency generated by the NICT are transmitted throughout Japan via standard radio waves (JJY\*). The master clocks of broadcasting stations and time signal services provided by telephone receive JJY and synchronize with JST. Standard radio waves transmitted by low frequency (LF) stations contain time-coded information on time, which is superposed on a highly precise carrier frequency signal.

The standard time and frequency signal is synchronized with the national standard maintained by the NICT. Even though a transmission signal is precise, the precision

of received signals may be reduced by factors such as conditions in the ionosphere. Such effects are particularly enhanced in the HF region, causing the frequency precision of the received wave to deteriorate to nearly  $1 \times 10^{-8}$  (i.e., the frequency differs from the standard frequency by 1/100,000,000). Therefore, low frequencies, which are not susceptible to ionospheric conditions, are used for standard transmissions, allowing received signals to be used as more precise frequency standards. The precision obtained in LF transmissions, calculated as a 24-hour average of frequency comparison, is  $1 \times 10^{-11}$  (i.e., the frequency differs from the standard frequency by 1/100,000,000,000). The Ohtakadoya-yama and Hagane-yama LF Standard Time and Frequency Transmission Stations are described on the final page. Note that although standard signals are continuously transmitted, they may be interrupted for the maintenance and inspection of instruments and antennas or to avoid damage due to lightning.

For detailed information on the standard radio transmission, please contact Japan Standard Time Service Group, Space-Time Standards Laboratory of NICT.

\* JJY is the call sign of the radio station and a registered trademark (T4355749) of the NICT.

## Range of LF standard time and frequency transmission

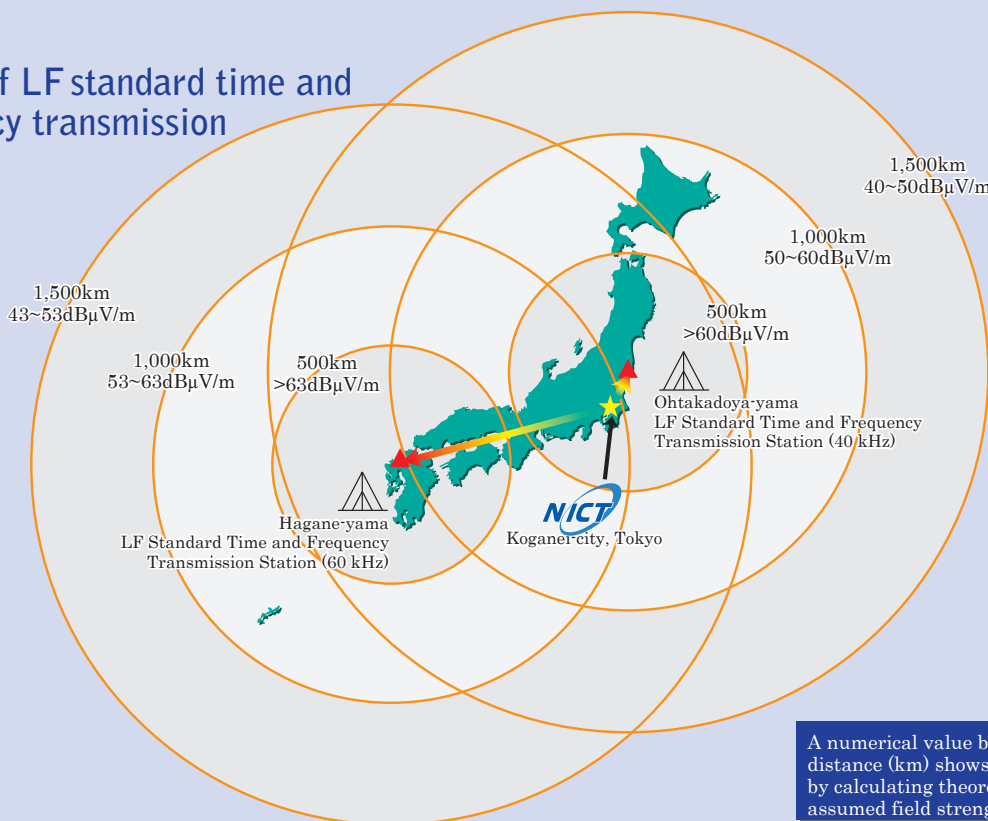

A numerical value below each distance (km) shows the value by calculating theoretically assumed field strength.

# Applications of LF Standard Time and Frequency Transmission

## Radio Clock

A radio clock automatically corrects the time through reception of the standard time and frequency transmission signal. In Japan, a device synchronizes time with JST by receiving either a 40 kHz signal from Ohtakadoya-yama LF Standard Time and Frequency Transmission Station or a 60 kHz signal from Hagane-yama LF Standard Time and Frequency Transmission Station of the NICT.

## Features of Radio-controlled Clocks

A radio-controlled clock has an automatic time-correction function to adjust the time periodically, from once a day to once an hour depending on the products. Radio clocks

work as general quartz devices until the next reception.

The precision of time synchronization may be within several milliseconds relative to JST.

Radio-controlled clocks need to be placed where standard waves are easily received to ensure the adjustment of time. (It takes several minutes to receive the signal before the time is adjusted.) They do not work properly in areas subject to high levels of radio noise (such as inside buildings and cars and near high-voltage power lines, electric appliances and O.A. devices).

## High-Precision Frequency Calibration

The received LF standard time and frequency transmission signal and the data released by the NICT make it possible to calibrate the standard frequencies of radio instruments and measuring instruments with precision on the order of  $10^{-11}$ .

## Observations

Standard time and frequency transmissions are used for the time records of astronomical observations (e.g., observations of meteors and occultation) and to synchronize the time for observations made with seismometers and meteorological instruments.

## Application Fields for LF Standard Time and Frequency Transmissions

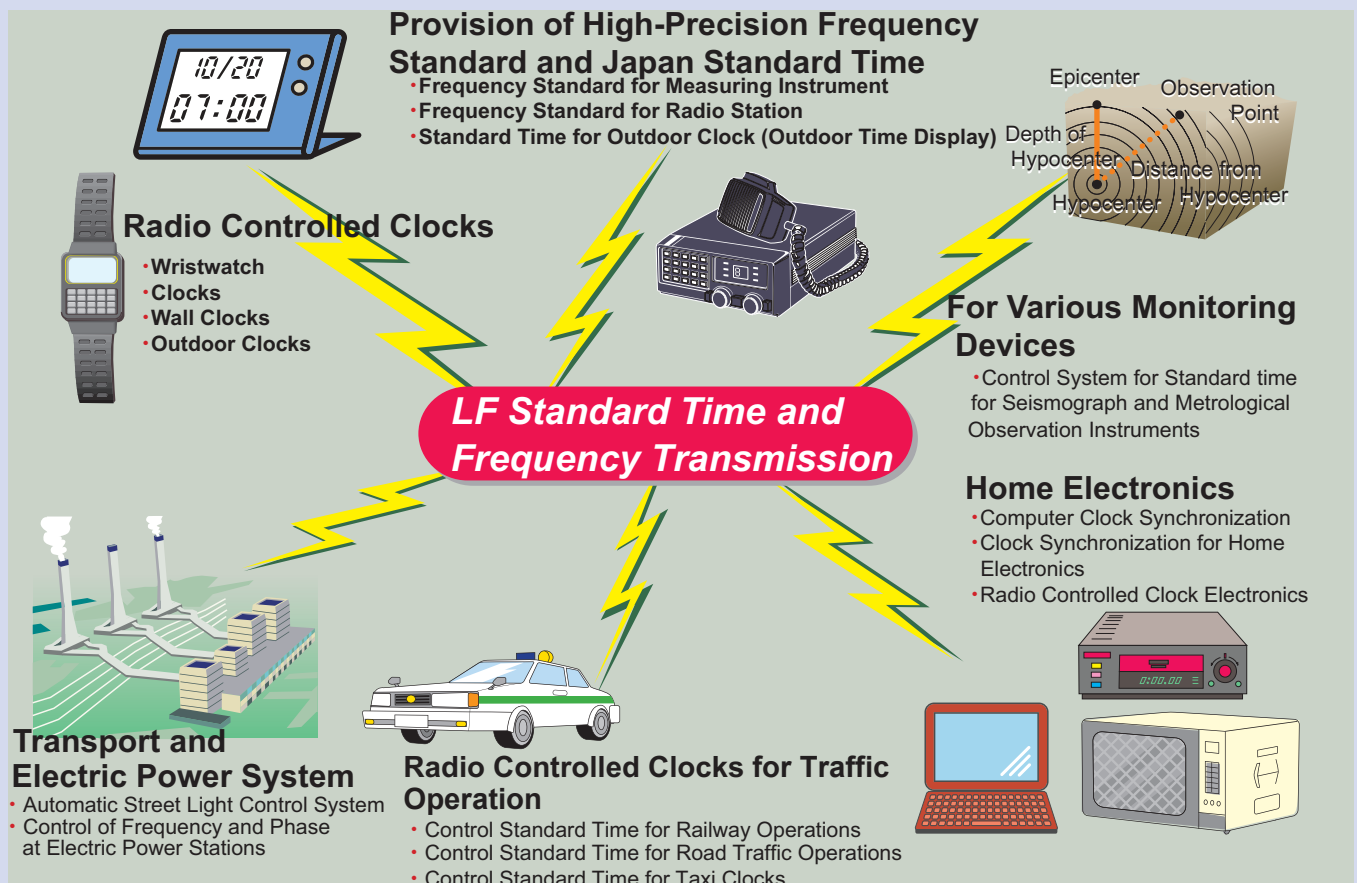

# Overview of LF Standard Time and Frequency Transmission Facilities

The standard frequency and time signal is generated by high-performance cesium atomic clocks operated in Clock Room. The signal is then amplified by a transmitter and impedance-matched to the antenna, and transmitted throughout Japan.



▲ Top of the umbrella antenna



▲ Standard time and frequency transmission station

The Koganei headquarters of the NICT generates, maintains, and disseminates JST.

## Block diagram of the signal transmission system of the standard time and frequency transmission station

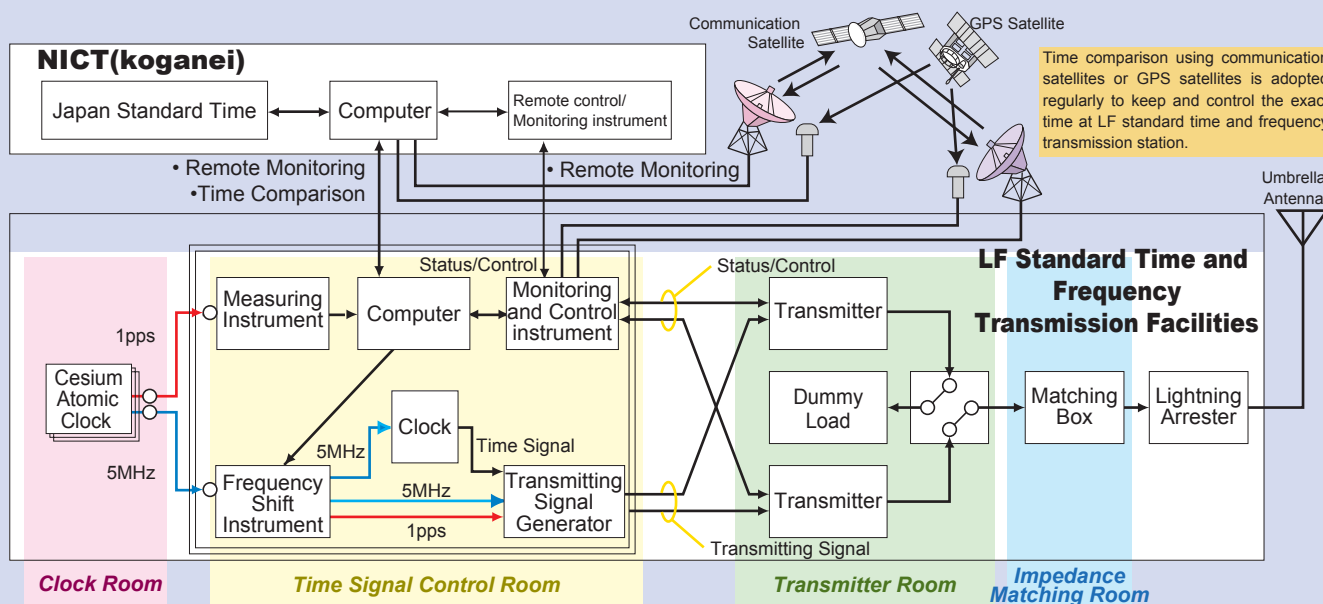

▲ The LF standard time and frequency transmission stations are equipped with a private electric generator to provide backup power during power outages.

## Clock Room

A clock room allows a high-performance cesium atomic clock to operate stably. The room is controlled to maintain certain temperature and humidity, and provides electromagnetic shielding. These features completely isolate the atomic clocks from changes in the surrounding environment.



## Transmitter Room

The transmitter room has two high-power transmitter systems (a main system and a back-up system) to amplify the signals to 50 kW. In the case of malfunction of the instruments in the main system or in the event of an emergency, the back-up system automatically takes over.



## Time Signal Control Room

The LF standard frequency signal and the time code are generated in the time-signal control room using the standard signals obtained with the cesium atomic clocks. Automatic control, data collection, and image-based monitoring of various instruments within the station are also performed in this room.



## Impedance-Matching Room

A matching transformer is installed in the impedance-matching room to match the impedance of the transmitter and antenna for efficient transmission. Since high-power radio waves pass through this room, generating a strong electric field, the inside walls are copper-shielded and are off-limits during transmission.



# Time Codes Provided by Standard Time and Frequency Transmissions

## Time Codes of Standard Time and Frequency Transmissions

The time code of the LF standard time and frequency transmission contains information on the hour, minute, day of year, year (the last two digits of the dominical year), day of week, leap second, parity for hours and minutes, and future transmission interruptions. The time code is expressed by a pulse train that switches the output levels of pulse signals between 100% and 10%. The transmission is designed for continual applicability as a frequency standard, with there being a continuous signal even during the low-level pulse (10%). This time code is mainly used for the synchronization of radio clocks.

### The Year 2100 Problem

Since the time code must represent a great deal of information in a limited number of bits, only the last two digits of the dominical year are used to indicate the year and the day is presented only as an annual date. The year of 2100 is not a leap year (since it is indivisible by 400). Radio clocks for which a leap year is set every four years will falsely recognize the year 2100 as a leap year and will display February 29. In the case that the standard transmission is to be used for 100 years or more, radio clocks produced since 2000 have been programmed to recognize the year 00 as a non-leap year.

## Determining and Reading the Time Code

### 1 Information Contained in Time Code

The time code gives the hour, minute, day of year, year (the last two digits of the dominical year), day of week, leap second, parity bits for hours and minutes, and notification of future transmission interruptions.

The hour, minute, day of year, year, and day of week are represented in binary terms [BCD (Binary Coded Decimal Notation) positive logic].

### 2 Second Signal

The start of each second corresponds to the rising of the leading edge of the pulse signal. The point at which the pulse reaches 55% of its full amplitude (midpoint between 10% and 100% amplitude) is synchronous with the second signal of standard time.

### 3 Pulse Width

Marker (M) and position markers (P0–P5) :  $0.2 \text{ s} \pm 5 \text{ ms}$

Binary 0 :  $0.8 \text{ s} \pm 5 \text{ ms}$

Binary 1 :  $0.5 \text{ s} \pm 5 \text{ ms}$

### 4 Output Interval

A code with a period of 60 seconds (60 bits) is transmitted every second.

### 5 Standard Time of Time Code

The time (year, annual date, hour, and minute) of the first marker (M) in each period is encoded and transmitted.

### 6 Marker (M) Position

The marker (M) corresponds to the exact minute (the zero second of each minute).

### 7 Positions of the Position Markers (P0–P5)

The position marker P0 normally corresponds to the rise of the 59th second (for non-leap seconds). However, for a positive leap second (insertion of a second), P0 corresponds to the rise of the 60th second (in this case, the 59th second is represented by a binary 0). For a negative leap second (removal of a second), P0 corresponds to the rise of the 58th second. Position markers P1, P2, P3, P4 and P5 correspond to the rise of the 9th, 19th, 29th, 39th, and 49th seconds, respectively.

## Representation of Information

- (a) Hour (six bits: 20h, 10h, 8h, 4h, 2h, 1h)  
The hour in Japan Standard Time (JST) in 24-hour representation
- (b) Minute (seven bits: 40m, 20m, 10m, 8m, 4m, 2m, 1m)  
The JST minute
- (c) Annual date (ten bits: 200d, 100d, 80d, 40d, 20d, 10d, 8d, 4d, 2d, 1d)  
The day of the year, counting January 1 as day 1. Thus, December 31 is expressed as 365 in a non-leap year and as 366 in a leap year.
- (d) Year (eight bits: 80y, 40y, 20y, 10y, 8y, 4y, 2y, 1y)  
The last 2 digits of the dominical year
- (e) Day of the week (three bits: 4w, 2w, 1w)  
Values 0–6 allocated to Sunday–Saturday.
- (f) Leap second information (two bits: LS1, LS2)  
The leap-second adjustment is performed immediately before 9:00 (Japan Standard Time) on the first day of the month in question. Leap-second information is continuously transmitted from 9:00 on the second day of the previous month to 8:59 on the first day of the relevant month.

- (g) Parity (two bits: PA1, PA2)  
Parity bits are signals used to determine whether the hour and minute signals are correctly read. PA1 and PA2 correspond respectively to the hour and minute. Each is one bit representing even parity.  
$$PA1 = (20h + 10h + 8h + 4h + 2h + 1h) \bmod 2$$
$$PA2 = (40m + 20m + 10m + 8m + 4m + 2m + 1m) \bmod 2$$
  
(mod 2 represents the remainder of division by 2)
- (h) Spare bits (two bits: SU1, SU2)  
Spare bits are reserved for additions of items to be contained within the time code (such as daylight savings time).  
To date, these bits have had a value of zero.
- (i) Notification of transmission interruption (six bits: ST1, ST2, ST3, ST4, ST5, ST6)  
When interruptions of standard time and frequency transmission are scheduled (e.g., for maintenance and inspection) advance notice is given using notification bits. When there are no plans for interruption, all spare bits have values of zero.

\*Detailed definition on each bit is given at

<https://jy.nict.go.jp/jy/trans/index.html>

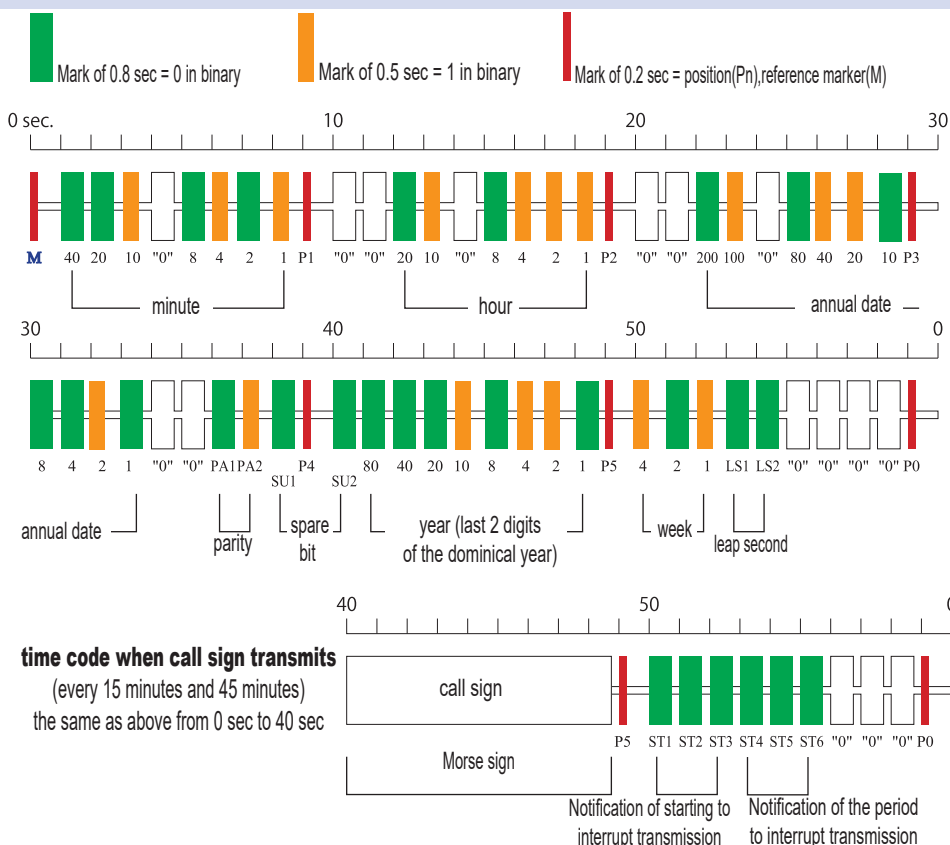

The time code communicates the time of the reference marker **M** position for 60 seconds. For example, left figure shows June 10 (annual day:162), 2016, Friday, 17:15 (There is no leap second within one month).

# Descriptions of the LF Standard Time and Frequency Transmission Facilities

## Ohtakadoya-yama LF Standard Time and Frequency Transmission Station

### 1. Location

Near the summit of Mt. Ohtakadoya on the border between Miyakoji, Tamura City and Kawauchi Village in Futaba County of Fukushima Prefecture

Elevation : approximately 790 m  
Latitude : 37° 22' 21" N  
Longitude : 140° 50' 56" E

### 2. Specifications of the Transmission Station

Name of the Station:  
Ohtakadoya-yama LF Standard Time and Frequency Transmission Station, National Institute of Information and Communications Technology (NICT)

Antenna Power: 50 kW  
(antenna efficiency: approx. 25%)

Radio Wave Mode: A1B  
Carrier frequency: 40 kHz  
Total area of station: approx. 88,668 m<sup>2</sup>

Antenna facility:  
Umbrella antenna, 250 m above ground

Operation:  
Continuous operation (except during maintenance and inspection of instruments and in the event of possible lightning)

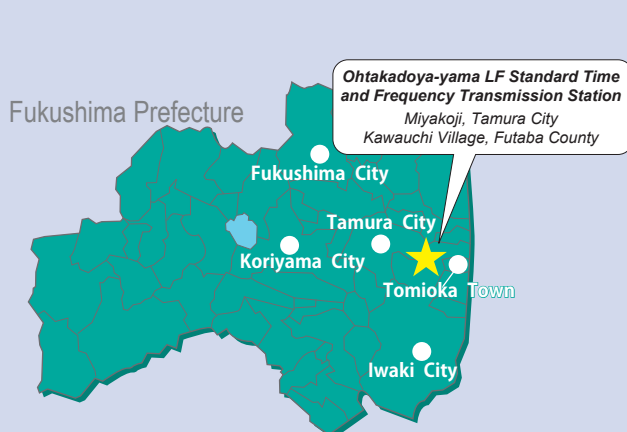

## Hagane-yama LF Standard Time and Frequency Transmission Station

### 1. Location

Near the summit of Mt. Hagane on the border between Fuji, Saga City of Saga Prefecture and Itoshima City of Fukuoka Prefecture

Elevation : approximately 900 m  
Latitude : 33° 27' 56" N  
Longitude : 130° 10' 32" E

### 2. Specifications of the Transmission Station

Name of the Station:  
Hagane-yama LF Standard Time and Frequency Transmission Station, National Institute of Information and Communications Technology (NICT)

Antenna Power: 50 kW  
(antenna efficiency: approx. 45%)

Radio Wave Mode: A1B  
Carrier frequency: 60 kHz  
Total area of station: approx. 115,803 m<sup>2</sup>

Antenna facility:  
Umbrella antenna, 200 m above ground

Operation:  
Continuous operation (except during maintenance and inspection of instruments and in the event of possible lightning)

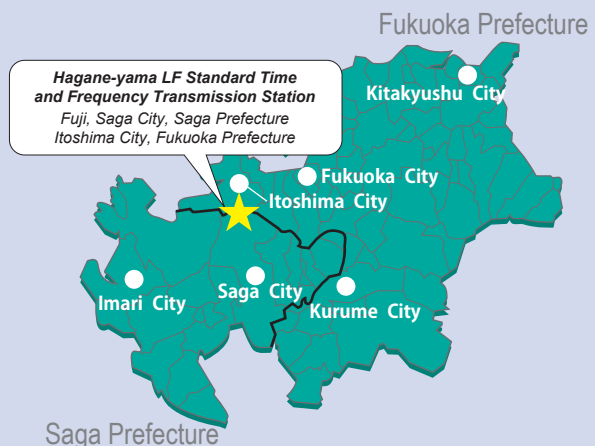

National Institute of Information and Communications Technology  
Radio Research Institute, Electromagnetic Advanced and Infrastructure Research Center  
Space-Time Standards Laboratory, Japan Standard Time Service Group  
4-2-1 Nukui-Kitamachi, Koganei, Tokyo 184-8795 Japan  
Tel: +81-42-327-6985 Fax: +81-42-327-6689 URL: <https://jyy.nict.go.jp> E-mail: [horonet@ml.nict.go.jp](mailto:horonet@ml.nict.go.jp)